

85BSD Digital Output

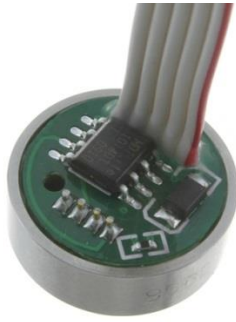

- Weldable or threaded process fittings
- Pressure/temperature read-out
- Digital output
- ASIC calibrated
- Absolute, gage
- Cable/connector option
- Low power option
- 13mm diaphragm diameter

DESCRIPTION

The 85BSD is a small profile, media compatible, piezoresistive silicon pressure sensor packaged in a 316L stainless steel housing. This 14-bit digital output pressure sensor supports I²C and SPI interface protocols in either a 3.3 or 5.0Vdc supply voltage, and is designed to be weldable or threaded with process fittings. The sensing package utilizes silicone oil to transfer pressure from the 316L stainless steel diaphragm to the sensing element.

The 85BSD is designed for high performance, low pressure applications. A custom ASIC is used for temperature compensation, offset correction, and provides a digital output of 10~90% or 5~95%.

For a similar sensor with o-ring mounting, refer to the 86BSD digital output pressure sensor.

FEATURES

- Weldable or threaded process fittings
- ±0.25% Accuracy
- ±1.0 Total Error Band
- Cable/connector option
- Low power option
- I²C or SPI Interface protocols

APPLICATIONS

- Level controls
- Tank level measurement
- Corrosive fluids and gas measurement systems
- Sealed systems
- Manifold pressure measurement
- Barometric pressure measurement
- Submersible depth monitoring

STANDARD RANGES

Range	psiG	psiA	Range	BarG	BarA
0 to 005	•		0 to .35	•	
0 to 015	•	•	0 to 001	•	•
0 to 030	•	•	0 to 002	•	•
0 to 050	•	•	0 to 005	•	•
0 to 100	•	•	0 to 007	•	•
0 to 150	•	•	0 to 010	•	•
0 to 200	•	•	0 to 014	•	•
0 to 300	•	•	0 to 020	•	•

Intermediate pressure ranges available, contact factory

85BSD Digital Output

PERFORMANCE SPECIFICATIONS

Supply Voltage: 3.3Vdc

Ambient Temperature: 25°C (unless otherwise specified)

PARAMETERS	MIN	TYP	MAX	UNITS	NOTES
Zero Pressure Output (10% ~ 90%)		666		Count Hex	1
Zero Pressure Output (5% ~ 95%)		333		Count Hex	1
Full Scale Pressure Output (10% ~ 90%)		399A		Count Hex	1
Full Scale Pressure Output (5% ~ 95%)		3CCB		Count Hex	1
Accuracy	-0.25		0.25	%Span	2
Total Error Band	-1		1	%Span	3
Pressure Resolution	0.008			%Span	
Temperature Accuracy	-1.5		1.5	°C	4
Temperature Resolution		0.1		°C	
Input Voltage Range	2.7	3.3	5.5	V	1
Supply Current		3		mA	
Insulation Resistance (50Vdc)	50			MΩ	5
Overpressure			2X	Rated	6
Burst Pressure			3X	Rated	7
Load Resistance (R _L)	10			KΩ	
Long Term Stability (Offset & Span)		±0.5		%Span/Year	
Compensated Temperature (≤5psi)	0		50	°C	
Compensated Temperature (≥15psi)	-20		+85	°C	
Operating Temperature	-40		+125	°C	8
Storage Temperature	-40		+125	°C	8
Output Pressure Resolution			14	Bits	
Output Temperature Resolution	8		11	Bits	
Start Time to Data Ready			8.4	ms	9
Output Type	10% to 90% or 5% to 95%				
Interface Type	I ² C (ADDR, 0x28H)				
	I ² C (ADDR, 0X36H)				
	I ² C (ADDR, 0x46H)				
	SPI				
Media – Pressure	Liquids and gases compatible with 316/316L Stainless Steel				

Notes

1. Measured at vacuum for absolute(A), ambient for gage(G) and sealed gage(S). Output is not ratiometric to supply voltage.
2. Accuracy: combined linearity, hysteresis and repeatability.
3. Total Error Band: includes calibration errors and temperature effects over the compensated range. See Figure 3.
4. The deviation from a best fit straight line (BFSL) fitted to the output measured over the compensated temperature range. For errors beyond the compensated temperature range, See Figure 2.
5. Between case and sensing element.
6. 2X or 400psi, whichever is less. The maximum pressure that can be applied to a transducer without changing the transducer's performance or accuracy.
7. 3X or 600psi, whichever is less. The maximum pressure that can be applied to a transducer without rupture of either the sensing element or transducer.
8. Maximum temperature range for product with standard cable and connector is -20°C to +105°C.
9. Start time to data ready is the time to get valid data after POR (Power on Reset). The time to get subsequent valid data is then specified by the response time specification.

Additional Notes

Sharp edge strongly recommended for welding applications. Optimum weld parameters will reduce the effect of weld heat on sens or performance. Devices with lower pressure ranges have greater susceptibility to heat generated during the weld process.

85BSD Digital Output

DIMENSIONS

DIMENSIONS ARE IN INCHES [mm]

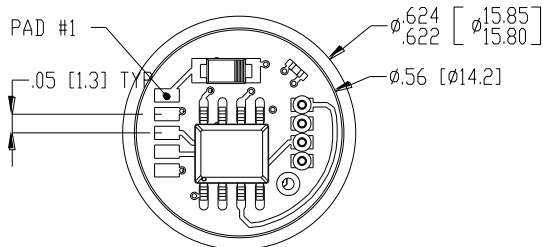
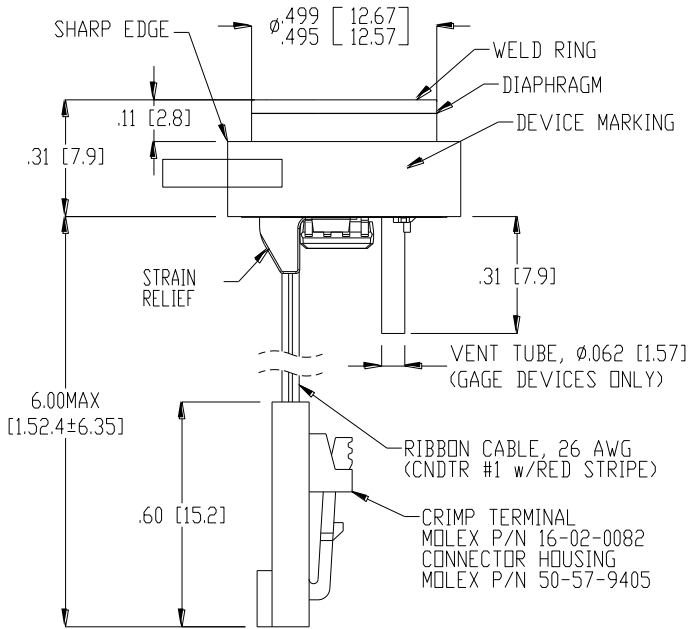

VIEW SHOWN w/o
CABLE AND CONNECTOR FOR CLARITY

-0 OPTION
(w/o FITTING)

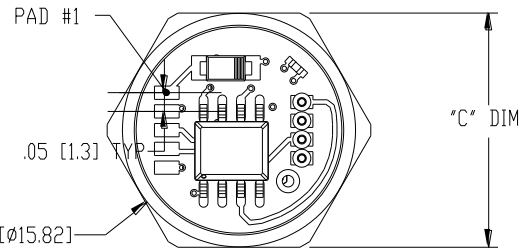
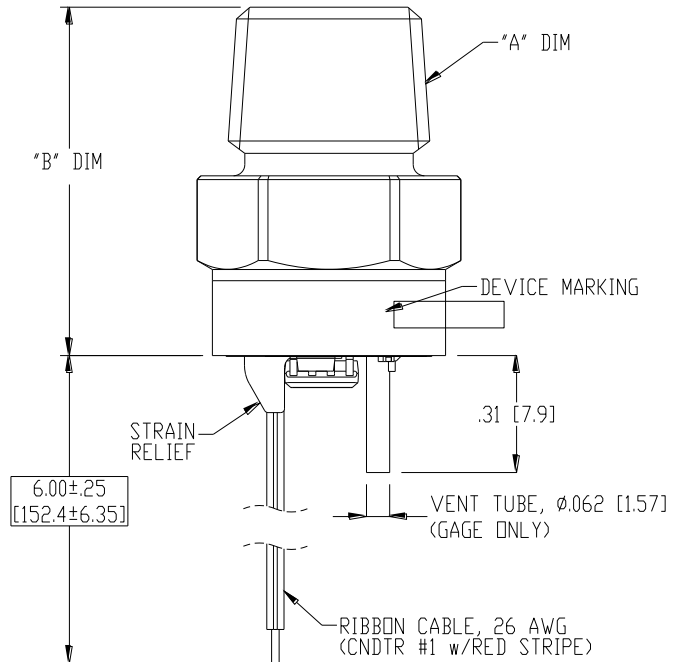

VIEW SHOWN w/o
CABLE FOR CLARITY
-4 OPTION
(1/4-18 NPT FITTING)

PAD/CNDTR	FUNCTION
1	VDD
2	GND
3	SCL/SCLK
4	SDA/MISO
5	INT/SS

FITTING TYPE	"A" DIM	"B" DIM	"C" DIM
4	1/4-18 NPT	.93[23.6]	5/8[15.9] HEX
5	1/4-19 BSP	.96[24.4]	3/4[19.0] HEX
8	1/8-27 NPT	.80[20.3]	5/8[15.9] HEX
0	w/o FITTING		
ALL DIMS ARE FOR REFERENCE			

85BSD Digital Output

BLOCK DIAGRAM

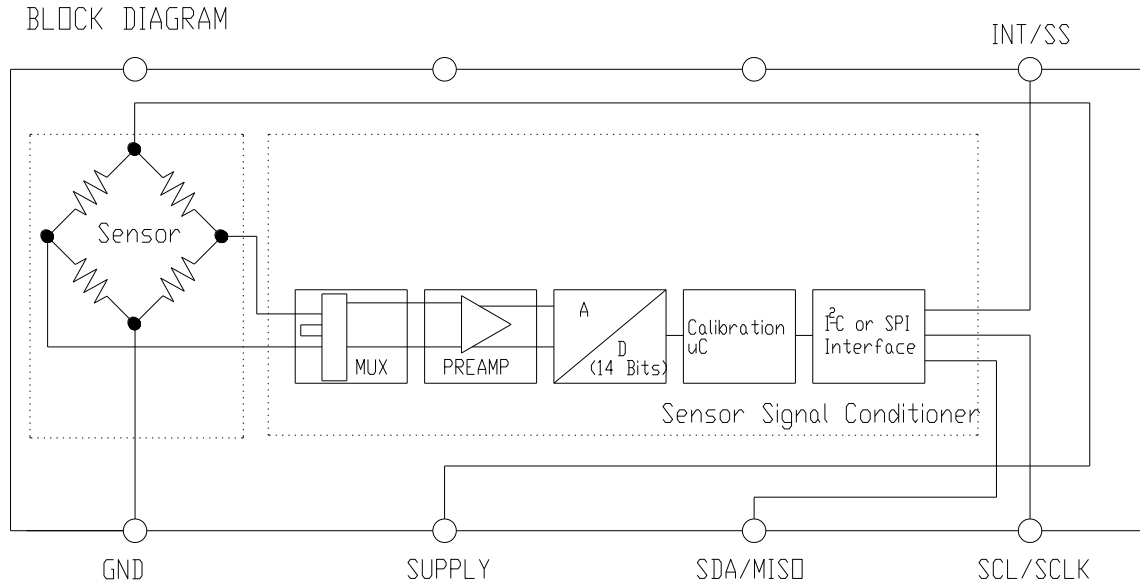

Fig 1

I2C INTERFACE PARAMETERS

PARAMETERS	SYMBOL	MIN	TYP	MAX	UNITS
SCLK CLOCK FREQUENCY	F _{SCL}	100		400	KHz
START CONDITION HOLD TIME RELATIVE TO SCL EDGE	t _{HDSTA}	0.1			μs
MINIMUM SCL CLOCK LOW WIDTH @1	t _{LOW}	0.6			μs
MINIMUM SCL CLOCK HIGH WIDTH @1	t _{HIGH}	0.6			μs
START CONDITION SETUP TIME RELATIVE TO SCL EDGE	t _{SUSTA}	0.1			μs
DATA HOLD TIME ON SDA RELATIVE TO SCL EDGE	t _{HDDAT}	0			μs
DATA SETUP TIME ON SDA RELATIVE TO SCL EDGE	t _{SUDAT}	0.1			μs
STOP CONDITION SETUP TIME ON SCL	t _{SUSTO}	0.1			μs
BUS FREE TIME BETWEEN STOP AND START CONDITION	t _{BUS}	2			μs

SPI INTERFACE PARAMETERS

PARAMETERS	SYMBOL	MIN	TYP	MAX	UNITS
SCLK CLOCK FREQUENCY	F _{SCL}	50		800	KHz
SS DROP TO FIRST CLOCK EDGE	t _{HDSS}	2.5			μs
MINIMUM SCL CLOCK LOW WIDTH @1	t _{LOW}	0.6			μs
MINIMUM SCL CLOCK HIGH WIDTH @1	t _{HIGH}	0.6			μs
CLOCK EDGE TO DATA TRANSITION	t _{CLKD}	0		0.1	μs
RISE OF SS RELATIVE TO LAST CLOCK EDGE	t _{SUSS}	0.1			μs
BUS FREE TIME BETWEEN RISE AND FALL OF SS	t _{BUS}	2			μs

@1 COMBINED LOW AND HIGH WIDTHS MUST EQUAL OR EXCEED MINIMUM SCL PERIOD.

85BSD Digital Output

TEMPERATURE ACCURACY / TOTAL ERROR BAND

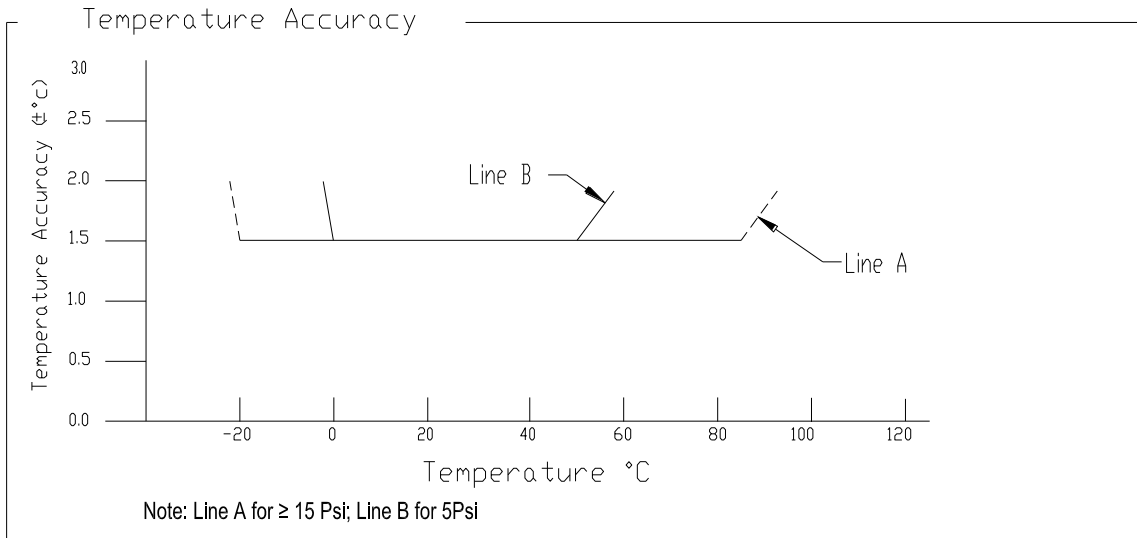

Fig 2

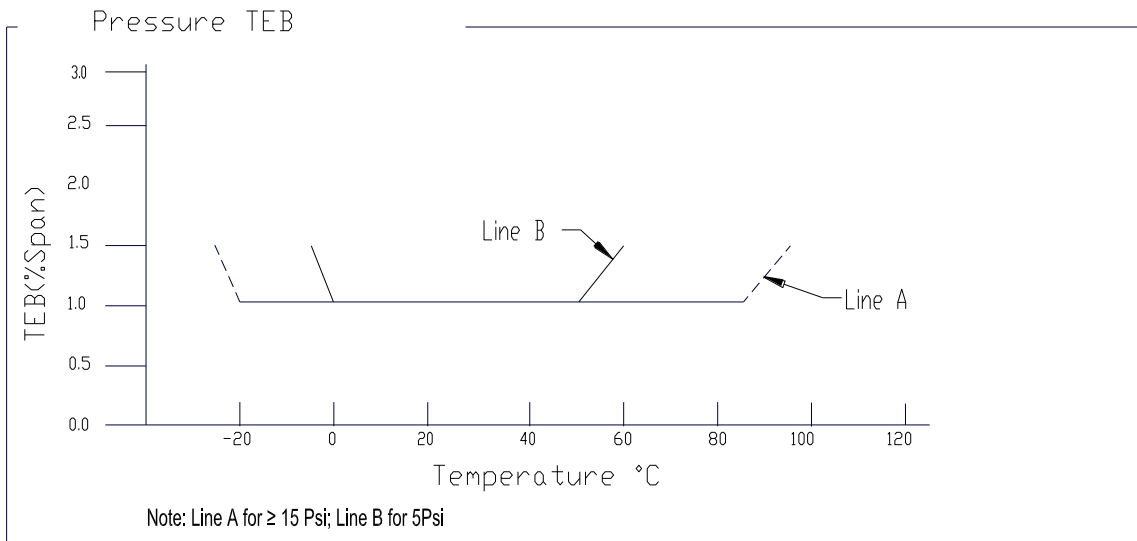

Fig 3

PRESSURE TRANSFER FUNCTIONS

Pressure Transfer Functions

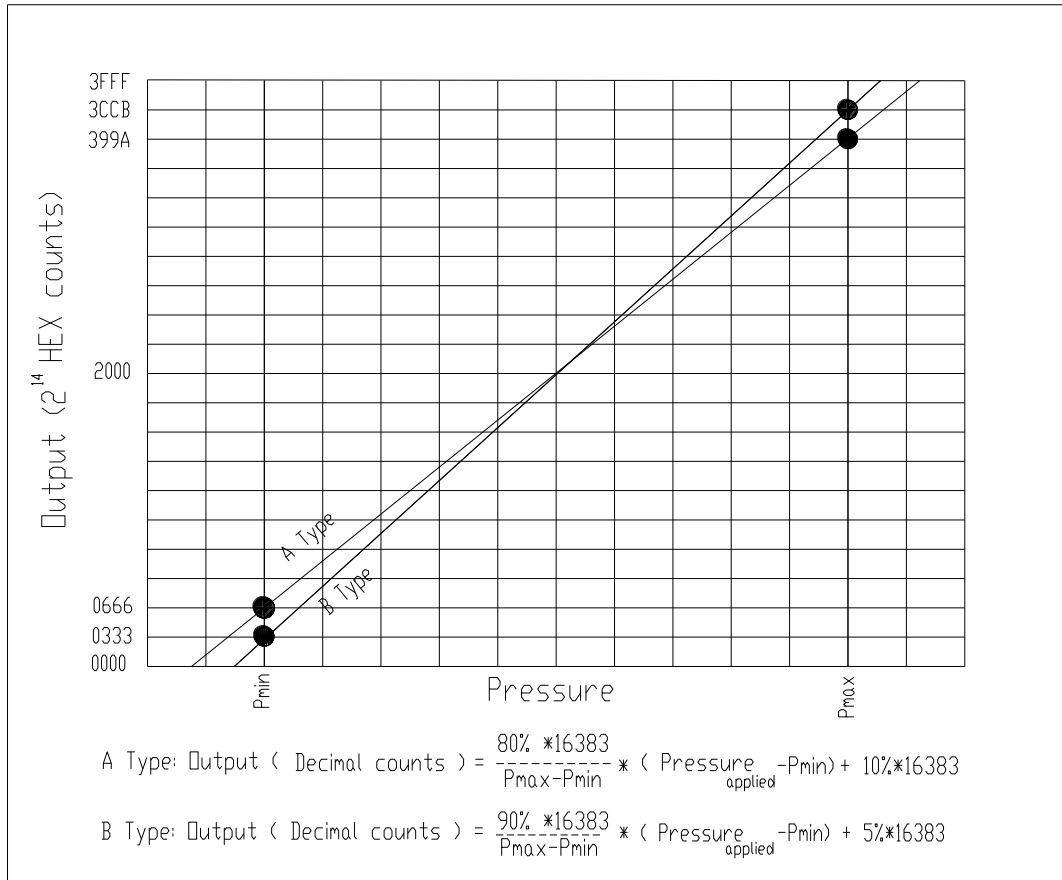

Fig 4

Sensor Output at Significant Percentages

% Output	Digital Counts (decimal)	Digital Counts (hex)
0	0	0 X 0000
5	819	0 X 0333
10	1638	0 X 0666
50	8192	0 X 2000
90	14746	0 X 399A
95	15563	0 X 3CCB
100	16383	0 X 3FFF

85BSD Digital Output

TEMPERATURE TRANSFER FUNCTIONS

Temperature Transfer Functions

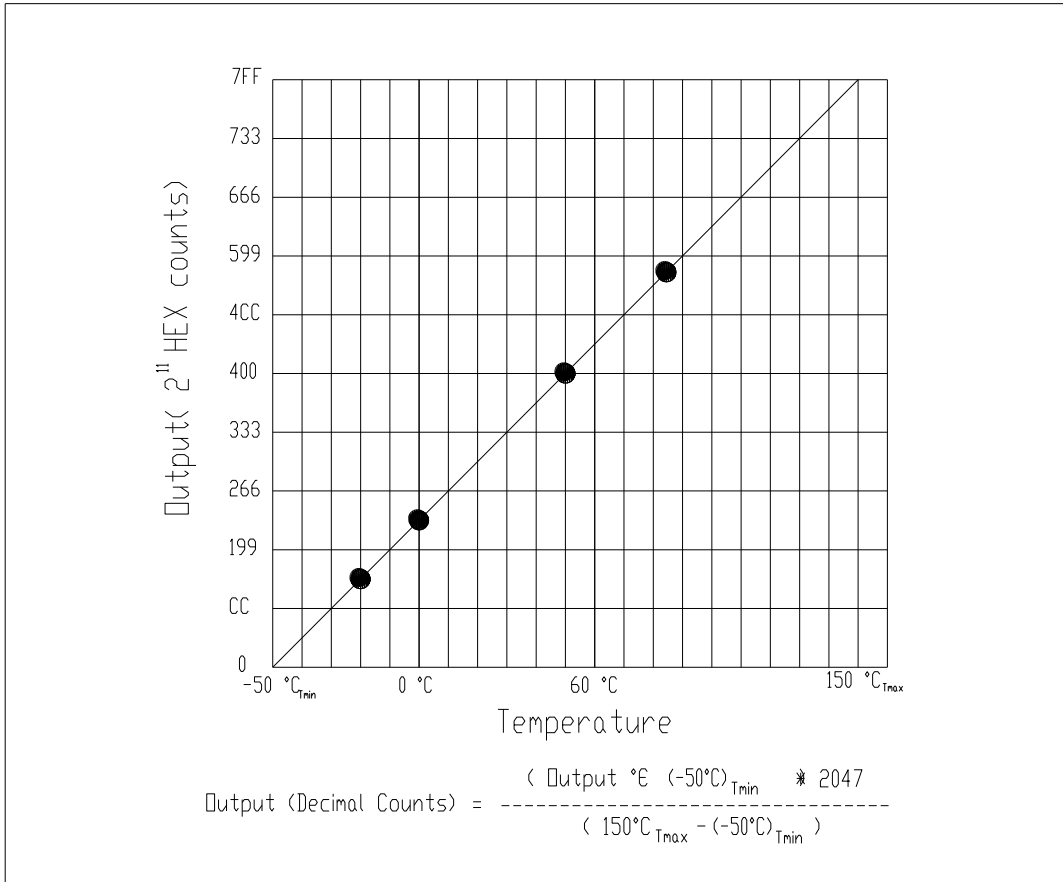

Fig 5

Temperature Output vs Counts

Output °C	Digital Counts (decimal)	Digital Counts (hex)
-50	0	0 X 0000
-20	307	0 X 0133
0	512	0 X 0200
25	767	0 X 02FF
50	1024	0 X 0400
85	1381	0 X 0565
150	2047	0 X 07FF

85BSD Digital Output

ORDERING INFORMATION

85B S D 015P A 4 - 3 A I C L

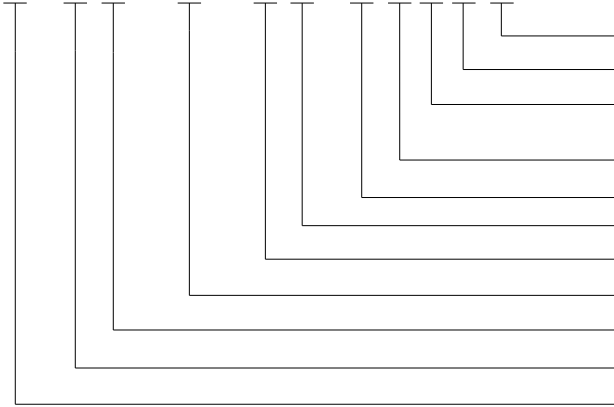

Low Power (Blank = None, L = Low Power)
 Connection (P = Pads, R = Ribbon Cable, C = Cable w/ Connector)
 Interface (I = I2C (ADDR. 0X28H, J = I2C (ADDR. 0X36H),
 K = I2C (ADDR. 0X46H, S = SPI)
 Output (A = 10~90%, B = 5~95%)
 Supply Voltage (3 = 3.3Vdc, 5 = 5.0Vdc)
 Fitting (See Fitting Table)
 Type (A = Absolute, G = Gage)
 Pressure Range
 Digital Output
 Stainless Steel
 Model

NORTH AMERICA

Measurement Specialties
 45738 Northport Loop West
 Fremont, CA 94538
 Tel: 1-800-767-1888
 Fax: 1-510-498-1578

EUROPE

Measurement Specialties
 (Europe), Ltd.
 26 Rue des Dames
 78340 Les Clayes-sous-Bois, France
 Tel: +33 (0) 130 79 33 00
 Fax: +33 (0) 134 81 03 59

ASIA

北京赛斯维测控技术有限公司
 北京市朝阳区望京西路48号
 金隅国际C座1002
 电话: +86 010 8477 5646
 传真: +86 010 5894 9029
 邮箱: sales@sensorway.cn
<http://www.sensorway.cn>

The information in this sheet has been carefully reviewed and is believed to be accurate; however, no responsibility is assumed for inaccuracies. Furthermore, this information does not convey to the purchaser of such devices any license under the patent rights to the manufacturer. Measurement Specialties, Inc. reserves the right to make changes without further notice to any product herein. Measurement Specialties, Inc. makes no warranty, representation or guarantee regarding the suitability of its product for any particular purpose, nor does Measurement Specialties, Inc. assume any liability arising out of the application or use of any product or circuit and specifically disclaims any and all liability, including without limitation consequential or incidental damages. Typical parameters can and do vary in different applications. All operating parameters must be validated for each customer application by customer's technical experts. Measurement Specialties, Inc. does not convey any license under its patent rights nor the rights of others.